

**D & E**

### 3.5 OWS (Outer Wheel Support) slider

**+Other brands**

Seldén OWS sliders are designed both as batten sliders and webbing sliders. Each model is available in 5 different versions. One version fits Seldén E-sections (1977-2002) and older Seldén/Kemp oval sections. Any of the other 4 versions fits most of all other mast brands on the market.

OWS sliders do not fit Seldén C-section for which MDS-sliders should be used.

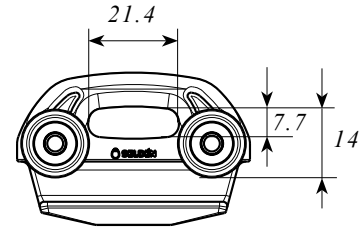

#### OWS slider for webbing

To achieve maximum strength, the OWS slider should be attached to the main sail using a webbing strap.

All sliders for webbing can be used for headboard attachments and as intermediate sliders.

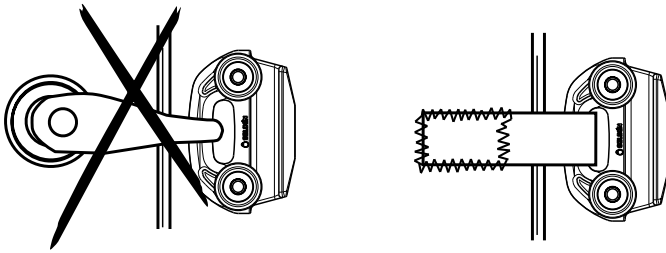
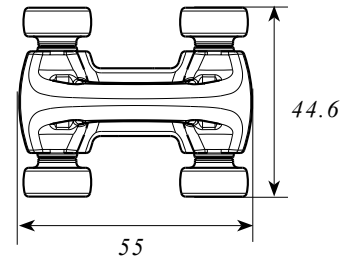

#### OWS slider for batten

The OWS batten slider is designed to take compression load from the batten in a full batten main sail. To achieve optimal function and strength, use Seldén toggle M10 stud 511-739-01.

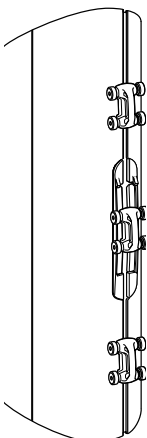
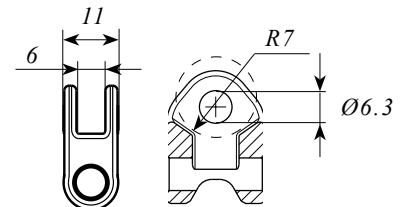
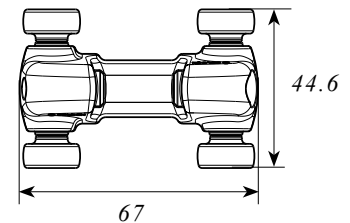
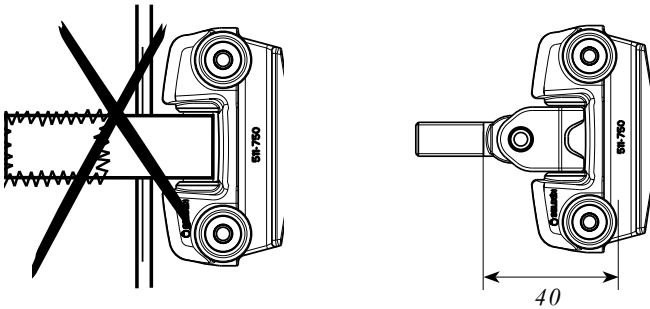
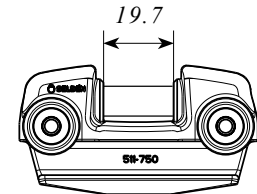

#### OWS compatible sail feeder gates

The OWS E-section slider (511-740 and 511-750) can be used with, and passes through Seldén sail feeder gate 505-501-01.

The OWS sliders 511-744 and 511-754 for keelboat sections (C106-C139) can be used with and passes through Seldén sail feeder gate 505-533-02.



























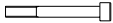























### 3.5.1 OWS slider - dimensions









Type	Measurements (mm)	Type	Measurements (mm)
OWS slider webbing 511-740		OWS slider batten 511-750	
OWS slider webbing 511-741		OWS slider batten 511-751	
OWS slider webbing 511-742		OWS slider batten 511-752	
OWS slider webbing 511-743 1)		OWS slider batten 511-753 1)	
OWS slider webbing 511-744		OWS slider batten 511-754	

All sliders for webbing can be used for headboard attachments and as intermediate sliders.

1) OWS sliders do not fit Seldén C-section for which MDS-cars, C (2003) or Inner Wheel Sliders, C (2017) should be used.

### 3.5.2 OWS slider - range

Type	Art. No.	Fits luff groove (mm)	Breaking load (N)	Assembly Art. No.	Parts Art. No.		
OWS slider webbing	 511-740	5.5	5000	 511-740-01			
OWS slider batten	 511-750	5.5	7000	 511-750-03	 511-750-01	 511-739-01 M10 screw	 153-117
				 511-750-02	 511-750-01		 153-117
OWS slider webbing	 511-741	10	5000	 511-741-01			
OWS slider batten	 511-751	10	7000	 511-751-03	 511-751-01	 511-739-01 M10 screw	 153-117
				 511-751-02	 511-751-01		 153-117
OWS slider webbing	 511-742	10	5000	 511-742-01			
OWS slider batten	 511-752	10	7000	 511-752-03	 511-752-01	 511-739-01 M10 screw	 153-117
				 511-752-02	 511-752-01		 153-117
OWS slider webbing	 511-743	12	5000	 511-743-01			
OWS slider batten	 511-753	12	7000	 511-753-03	 511-753-01	 511-739-01 M10 screw	 153-117
				 511-753-02	 511-753-01		 153-117
OWS slider webbing Big wheel	 511-744	5.5	5000	 511-744-01			
OWS slider batten Big wheel	 511-754	5.5	7000	 511-754-03	 511-754-01	 511-739-01 M10 screw	 153-117
				 511-754-02	 511-754-01		 153-117

Type	Fits mast section (only geometric fit)						
	Seldén			John Mast	Soromap	Sparcraft	Z-spars
OWS slider webbing 511-740 	E-section (10° aft face)	E-section (round aft face)	D-section	135D 148D 150D 165D 167D 185D 186D 208D 222D 245D 280D 305D 335D	NF200 NF270 NF350 NF430 NF540 NF710 NF1410	F135 F195 F305 F385 F460 I620 S622 S830 I830	Z301 Z351 Z380 Z401 Z501 Z531 Z601 Z602 Z701 Z702
	138/95 155/104 170/115 177/124 189/132 206/139 224/150 237/162 274/185	147/95 162/104 178/115 216/139 239/162	129/100 137/113 146/112 160/132				
OWS slider batten 511-750 							
OWS slider webbing 511-741 							
OWS slider batten 511-751 							
OWS slider webbing 511-742 							
OWS slider batten 511-752 							
OWS slider webbing 511-743 				220E 262E 290E		NG60 NG70 NG80 NG86 F580 F740 F1060 F1395 S1630 S2100 F2390 F3360 F4600	Z902 Z1001 Z1250 Z1400
OWS slider batten 511-753 							
OWS slider webbing Big wheel 511-744 	C-section			150E 116E 125E		F35 F50 F67 F78 F101 S137 S180 S260 S330 IMS80 IMS256	Z170 Z190 Z230 Z265
	C106 C116 C126 C139						
OWS slider batten Big wheel 511-754 